

J *Class*
30 *Association*

By-Laws
Class Rules and
Specifications

Draft Rev 0.0

Effective
January 1, 2013

Highlights of the 2013 edition of the Class Rules and Specifications:

Rule Changes & Interpretations effective 1 January 2013

- Allows up to two shackles as a replacement for optional removal of jib horns (5.4.1.11)
- Allows removal of cowl vent fitting on foredeck (5.4.1.12)
- Adds Rig-Rite jib box assembly part numbers supplied as standard equipment on original masts and authorizes replacement use with specified mounting locations (5.7.4.4)
- Permits the use of hanks on headsails as an alternative to a jib luff groove system (5.8.1.2.1)
- Removes limit on maximum number of races permitted for the North American Championship. The class has published a set of guidelines for hosting North American Championships which negate the need for the maximum number of races being specified (6.9.2)
- Administrative change to correct the spelling of “leach” to “leech” (5.12.2.3, 5.12.2.5, 5.12.3.4, 5.12.5.2, 5.12.6.2)

Rule Changes & Interpretations effective 1 April 2009

- Makes the quarter-berth cushions optional so they may be removed for racing (5.3)
- Competition Composites of Ottawa, Ontario, Canada is added as an approved source for replacement rudders built to J/30 original specifications and specifies a minimum weight of 60 pounds. (5.6.1)
- Provides administrative reference to J/30 insignia on sail plan that was misplaced when rules were updated over time (5.15.3)
- Updates the list of required safety equipment referring to Coast Guard regulations, and augments the list with one design required equipment and suggested optional safety equipment. The list has been reordered and grouped *Coast Guard Required*, *One Design Required*, and *Optional Suggested*. (6.4)

Rule Changes and Interpretations effective 1 July 2008

- Makes the V-Berth Cushions optional so they may be removed for racing (5.3)
- Permits alternate single or double burner stove mounted in same location with specified minimum weight (5.3)
- IdaSailor Marine of Boise, ID is added as an approved source for replacement rudders built to J/30 original specifications and specifies a minimum weight of 60 pounds. (5.6.1)
- Consolidates By-Laws, Class Rules & Specifications under a single document, as last done in 1999
- The drawings for the keel, rudder, mast, and shaft/prop installation have been “remastered” for readability. There is no intention to change information or dimensions that have remained the same since the original drawings were provided 5/9/80 by Rod Johnstone.

Rule changes and interpretations effective 1 April 2005

- Permits removal of jib tack horns and replacing with single shackle. (5.4.1.11)
- Permits use of carbon fiber spinnaker pole as alternate to aluminum. (5.11.1)
- Allows sail cloth material for mainsails to include polyethylene terephthalate ("PET"), such as Dacron®, or woven ply polyethylene naphthalate ("PEN"), such as Pentex®. (5.12.1.2)
- Allows any sail cloth material for #1, #2, and #3 Genoa. (5.12.1.3)
- Makes Genoa #2 optional to have on board while racing (5.12.1.5, 6.2.1)
- Defines cloth weight and allowable material for spinnakers (5.12.6.1)
- Defines roll tacking & roll gybing as not being a "necessary task" under the racing rules (6.3.2)
- Updates list of safety gear required to be carried onboard (6.4)
- Defines helmsman requirements for one-design Class events (6.6.1, 6.6.2, 6.6.3)
- Defines ownership to include owner's immediate family (6.6.5)
- Defines eligibility for national championship events, eligibility to helm loaned / chartered boats and ability for local fleets to modify helmsman rule for local events. (6.6.6, 6.6.7, 6.6.8)
- Defines North American Championship requirements including measurement and limits the number of races to seven (6.9, 6.9.1, 6.9.2)

Rule changes and interpretations effective 1 July 2004

- Permits use of similar sized stainless steel, or plastic as replacement materials for original wooden handrails (5.4.3)
- Permits substitution of plastic as replacement material for original wooden toe rails (5.4.10)
- Permits relocation of deck blocks, fairleads, and cleats, for spinnaker sheets, topping lift, foreguy, backstay adjuster, traveler controls, cunningham, outhaul, reefing gear, twings, and halyards (5.9.1.2)
- Permits addition of blocks and cleats to control inboard position of spinnaker pole (5.9.1.8)
- Requires a bridle on the spinnaker pole with no material limits on the bridal (5.11.3)
- Permits composite end fittings for spinnaker pole, precludes use of trigger mechanism for holding jaws open (5.11.4)
- Changes required safety gear & equipment requirements from ORC category 4 to USCG and local regulations and adds a list of required items (6.4)
- Removes restriction on number of crew as long as total crew weight limit of 1400 pounds is not exceeded (6.7)

Rule changes and interpretations effective 1 July 1999

- Rig-Rite, Inc. of Warwick, RI is now the supplier of Kenyon Spars. Hall Spars of Bristol, RI is also an approved mast builder. (5.7.1)
- Additional methods of spreader bracket repair and reinforcement have been approved (Rule 5.7.4, Mast Hardware).
- Without changing the rule's intent, sail cloth terminology has been revised to specify woven polyester (Dacron or nylon) for all sails. Mylar may be used for Genoa #1 and

there are no restrictions on sail cloth for the Genoa #3. An interpretation in the form a description of the material has also been added. (5.12.1.2)

- The specified minimum weight for Mylar used in the Genoa #1 has been eliminated. (5.12.5.1)
- The Crew Limit has returned to the seven person limit that was in place from 1979 until 1993. Additionally, there are two alternatives for those who wish to carry more crew. Eight may be aboard if any three crew weights sum to 400 pounds or less, or any number may be aboard if their total weight is 1400 pounds or less. (6.7.1)
- Family members under the age of 13 do not count toward crew number or weight limits. (6.7.1-2)

Rule changes and interpretations effective 1 January 1997

- Vang purchase restrictions have been eliminated. (5.9.1.2)
- Swivel base mainsheeting systems are permitted. (5.9.1.2)
- The #3 may be made from woven cloth or any laminated materials (including Mylar / Kevlar) with no minimum cloth weight. (5.12.1.2 & 5.12.3)
- Battens may be made of any material. (5.12.2.5 & 5.12.3.4)
- Loose footed mainsails are legal. (5.12.2.7)
- Integrated instruments calculating true wind speed and magnetic wind direction may be used. (6.1.1).
- Navigation equipment is no longer limited to Loran C, RDF and GPS. (6.1.5)
- Two class legal spinnakers may be carried, the second to be used only in case of damage to the first. (6.2.1)
- The anchor must still be stored in the anchor well, but the chain may now be attached either to the anchor or anchor line. (6.5)
- The "Helmsman Rule" was revised to treat single owners, joint owners and charterers uniformly and to recognize the importance of District qualifying procedures in determining eligibility for National events. (6.6.3)

Changes prior to 1997

- Sparcraft of Charlotte, NC, (as the successor to I.M. Isomat and Kenyon Spars) joins Hall Spars of Bristol, RI and LeFeill Marine Products of Sante Fe Springs, CA as approved mast builders. (5.7.1)
- Solid vangs are legal. (5.9.1.7)
- Removal of the boom topping lift is permitted. (5.9.1)
- The crew weight limit (including skipper) is 1400 pounds. (6.7)

Class Association By-Laws

I. The Class Association shall be governed by a Board of Governors. The Board of Governors shall have the authority, at a meeting called for such purpose, to amend, alter, add to, or repeal the Class Rules and One-Design Specifications. The Board of Governors shall consist of the following.

- A. Class President:** The president shall be elected by the Board of Governors every two years at the North American Championships. The President shall be Chief Administrator of the Class, and shall appoint a Secretary and others to assist him.
- B. District Governors:** One District Governor shall be elected by class members from each geographical District as described in article II, below. Upon failure to so elect by Feb. 1 of each year, a District Governor shall be appointed by the Class President.
- C. Chief Measurer:** The Chief Measurer shall be appointed by the Class President with approval of the Board of Governors.
- D. J-Boats, Inc. Representative:** This representative shall be selected by J-Boats, Inc.
- E. Immediate Past Class President**
- F. At-Large Members (up to three):** At-large members may be appointed by the Class President with approval of the Board of Governors.

II. Districts comprise the geographical areas as listed below. Within the several Districts, Fleets may be organized by not less than three (3) full members of the Association. The District Governor of the District shall be notified of all Fleet organizations.

- A. Northern New England:** Southeastern Canada, Atlantic Coast from Canada to and including Eastern Cape Cod.
- B. Southern New England:** Chatham, MA, to and including Mystic, CT.
- C. Long Island Sound:** From Mystic, CT, to and including Atlantic City, NJ, and Long Island.
- D. Chesapeake:** From Atlantic City, NJ, to the North Carolina state line.
- E. Carolina's:** North and South Carolina.
- F. Southeast:** Georgia, Eastern Florida and the Florida Keys.
- G. Gulf Coast:** Western Florida, Alabama, Mississippi, Louisiana and Texas.
- H. California:** Arizona and California.
- I. Pacific Northwest:** Oregon, Washington and British Columbia, Canada.
- J. Western Great Lakes:** Lakes Superior, Michigan and Huron.
- K. Eastern Great Lakes:** Lakes Erie and Ontario, upstate New York and Vermont.

III. Fleet officers shall consist, at a minimum, of the following.

- A. Fleet Captain**
- B. Fleet Measurer**

J/30 National Class Rules

Recently revised or new text is shown in bold italics.

Official interpretations made by the J/30 Class Association Chief Measurer are shown within double lines.

Notice to Owners and Sailmakers

It is impossible to foresee every conceivable innovation which may be thought of in the future and to mention every suggestion that has been ruled illegal in the past. When considering anything in connection with the boat or sails or equipment which is not within established practice in the J/30 Class or is not clearly covered by the plans or specifications, you must assume that it is illegal, and must obtain a ruling from the Chief Measurer before attempting it.

Rules and Specifications

The following rules and specifications shall govern J/30 events until modified, altered, added to, or repealed by the J/30 Class Association Board of Governors, effective *1/1/2013*.

J/30 events include all J/30 one-design races. One-design racing is defined as races with a J/30 start or races which score J/30s separately. A boat conforming to these rules should rate as a J/30 under performance or measurement handicapping systems.

Where specifically permitted in these rules, local fleets and organizers of a J/30 one-design event or series may adopt modifications, exceptions and additions to these rules which shall apply to local racing only.

1. One Design

1.1 The J/30 is a one-design class, created to fulfill the diverse needs of recreational sailors such as cruising, one-design racing, day sailing, handicap and offshore racing. These rules are intended to preserve important design characteristics: ease of handling, low cost of ownership, safety and comfort.

1.2 It is the intent of the J/30 Class Association and J/Boats, Inc. to maintain the one-design performance characteristics of the J/30. To this end, any substantive change that alters the weight, distribution of weight, shape or performance of the hull, rig or underwater appendages shall be submitted by J/Boats, Inc. to the J/30 Board of Governors for approval prior to implementation.

1.3 Except where variations are specifically permitted, yachts of this Class shall be alike in hull, deck and keel form, construction, weight and weight distribution, shape of rudder, sail plan and equipment. All boats shall be built in accordance with the plans, specifications and these class rules. No alternatives or modifications are permitted unless explicitly stated in these rules or on the official plans or building specifications.

1.4 Modifications shall be defined to include coring, drilling out, rebuilding or replacing materials, grinding, removing or relocating standard equipment in any way to reduce weight, to improve moments of inertia, or to change standard shapes, and filling in or closing with flaps any standard through hull fittings.

1.5 These Class Rules, however complete, cannot anticipate every situation which may arise. Owners should assume that anything not specifically permitted is prohibited until a ruling by the Chief Measurer is obtained.

1.6 Official interpretations of these rules shall be made by the Chief Measurer of the J/30 Class Association who may consult with the Class Board of Governors or the Class President or the International Sailing Federation (ISAF). Fleet Measurers shall consult with the Chief Measurer when making interpretations of these rules at the local level. Interpretations of local rules shall be made by the Fleet Measurer who may consult with the local fleet organization.

1.7 These Class Rules may be amended, altered, added to, or repealed by a majority of the members of the Board of Governors present and voting at a meeting called for such purpose on at least 30 days notice. A quorum shall consist of 40% of the Governors who were serving at the time of the notice, and no action shall be taken without a quorum.

2. Administration

2.1 Language. The official language for the class shall be English. The word “shall” is mandatory. The word “may” is permissive. In the event of dispute over class rule interpretation, the English text shall prevail.

2.2 Builders. J/30s shall be built only by builders licensed to do so under the copyright of J/Boats, Inc. (557 Thames St, Newport, RI 02840) and shall comply with the building specifications detailed by the copyright holder.

2.2.1 Building License. Applications for building license shall be made to J/Boats, Inc., who shall request that the national authority of the country concerned indicates its support for the applicant.

2.3 Building Fee. The building fee shall be payable to J/Boats, Inc. when the molding of the hull commences.

2.4 Registration and Measurement Certificates

2.4.1 No yacht shall be deemed to be a J/30 until it has been completed with a building number assigned by J/Boats, Inc. molded into the transom.

2.4.2 The sail number shall be as required by a national authority or shall be that of the hull number.

2.4.3 No yacht shall race unless a current valid measurement certificate has been issued. This provision may be waived or modified by local fleets or event organizers.

2.4.4 Any alteration to the hull, keel, rudder, spars or other item of equipment measured by these rules or a major repair to any item may invalidate the measurement certificate and yacht.

3. Owner's Responsibility

3.1 It is the responsibility of the owner to ensure that the yacht complies at all times with the current class rules.

3.2 No yacht shall race unless the owner(s) and helmsman(men) are full members of the J/30 Class Association. Local fleets, event organizers and other jurisdictions may require additional memberships.

4. Measurement

4.1 Tolerances are given in these rules and plans only to permit minor building errors or distortion through age.

4.2 Supplementary Measurements may be taken by an official measurer to ensure that construction, equipment, and practices do or do not accord with Class Rules. If the measurer considers an attempt has been made to depart from the One-Design Construction or these rules in any detail, or if he is unsure of any interpretation, he shall report the facts to the Chief Measurer.

4.3 Sails which are new or substantially altered are to be measured by an official measurer who will stamp or sign and date the sail near the tack. This provision may be waived or modified by local fleets or event organizers.

4.4 Vested Interest. A measurer shall not measure a yacht, spars, sails, or equipment owned or built by himself, or in which he is an interested party or has a vested interest. Prior approval to do so may be granted by the Class President or Chief Measurer.

4.5 ISAF Measurement Instructions and Racing Rules. Except where other methods of measurement are clearly indicated in the Class Rules, the ISAF measurement instructions and ISAF racing rules shall apply.

4.6 All templates shall be made only from offsets approved by J/Boats, Inc.

5. Construction & Measurement Rules

5.1 Production Molds for hull, deck, interior, hatches, and rudder shall be made from molds obtained from the one current official master plug. The casting pattern for the fin keel shall be cast from the one current official master pattern. The shape and forms of the patterns, plugs, and molds shall not be amended or altered unless specifically authorized by J/Boats, Inc.

5.2 Hull and Deck construction shall be in accordance with approved laminate, general arrangement, construction plans and techniques, and specifications approved by J/Boats, Inc.

5.3 Interior Equipment supplied with the standard boat from the factory may not be deleted or substituted for except by equivalent items of comparable weight or as specifically authorized below. Optional equipment offered by the builder or comparable equipment installed by the dealer or owner is permitted as are other items such as shelves or drawers to personalize the interior.

Standard interior equipment includes (but is not limited to) the following:

- cushions for all berths and settees (V-berth and quarter-berth cushions may be removed for racing)
- stove (In lieu of the original stove a replacement single or double burner stove is allowed that fits where the original stove is located. Adjustments to mounting may be made to accommodate dimension variations, as long as the original intended location is maintained. The replacement stove may use alcohol or gas (butane, propane, etc.). The replacement stove and associated cover / cutting board with fuel shall weigh 18 pounds minimum with weights permitted to augment as required.)
- bulkhead door
- water tank
- holding tank
- folding tables except main cabin table
- storage bin covers

Optional interior equipment includes the following:

- plastic tubs in storage compartments
 - teak and holly sole
 - main cabin table
 - hot water tank
-

5.4 Deck Gear. No additions, relocations, or modifications are permitted except as herein provided.

5.4.1 Permitted Alterations or Additions:

5.4.1.1 Four pairs of deck padeyes to assist trimming of headsails or for use as boom preventers along with related blocks, cleats, and rope tackle.

5.4.1.2 Alternative mooring cleats and chocks.

5.4.1.3 Handrails or foot blocks. Original equipment handrails may be replaced with comparably sized handrails of wood, stainless steel or plastic.

5.4.1.4 Deck prisms and/or ventilators which must be watertight when sealed shut.

5.4.1.5 Replacement of original winches (one pair each Bariant #10 halyard, #21 secondary and #25 primary) with those of similar size and power ratio, with or without self-tailing mechanisms, provided they remain in the same position as the original winches substituted for.

A list of approved replacement winches is available from the Class Measurer.

5.4.1.6 Forward jib sheet tracks may be relocated fore and aft in line with the factory drilled holes so that no part of the track is more than 640 mm aft of the shroud chainplates, nor more than 330 mm forward of the shroud chainplates.

5.4.1.7 A padeye, in addition to other allowable padeyes, may be located on the centerline between the mast and the forward hatch and may be used as an alternate location for the spinnaker pole downhaul.

5.4.1.8 The standard traveler car and track may be replaced with an equivalent system. The traveler track or bar may be raised to provide clearance. Automatic release, self-tacking or windward sheeting traveler cars are permitted.

5.4.1.9 Fixed-position or swivel base mainsheet cleat(s) may be attached to or in close proximity to the traveler.

5.4.1.10 Substitution of plastic for wood toe rails.

5.4.1.11 Removal of the Jib Tack Horns and replacing them with *up to two shackles* attached to existing hole of bow fitting.

5.4.1.12 *Cowl vent fitting on foredeck is optional and maybe removed.*

5.4.2 Prohibited Alterations or Additions:

5.4.2.1 Thru-deck running or standing rigging controls or thru-deck spinnaker launchers.

5.4.2.2 Lifeline stanchions which project outside a vertical line from the gunwale, lifelines attached to other than standard location on bow pulpit, and stern rail, or lifeline droop exceeding 125 mm with a 5 kg weight suspended between the pulpit and first stanchion.

5.4.2.3 Relocating or changing the length of the mainsheet traveler or the use of an alternative mainsheet bridle system.

5.4.2.4 Use of other than standard located jib tack hooks.

5.4.2.5 Removal or relocation of winches, not withstanding

5.5 Keel

5.5.1 Casting of Keel. The fin keel shall be manufactured by approved builders only from the official pattern and shall be of lead.

5.5.2 Weight of Keel. The weight of the fin keel shall be 935 kg plus or minus 20 kgs.

5.5.3 Coating of keel may be by any synthetic material provided the shape and weight are within template tolerances.

5.5.4 Trailing Edge. The trailing edge of the keel shall not be narrower than 5 mm.

5.6 Rudder

5.6.1 Construction. The rudder shall be made only by approved builders according to official plans. The trailing edge shall not be narrower than 5 mm. The rudder shall weigh no less than 60 pounds, excluding mounting hardware.

Approved rudder builders include IdaSailor Marine of Boise, Idaho and Competition Composites of Ottawa, Ontario Canada.

5.6.2 Tiller and tiller extension may be altered in length and material, but must be equivalent to that provided by the builder.

5.7 Mast

5.7.1 Material shall be of aluminum alloy extrusion with a continuous fixed groove integral with the spar, and shall be produced only by an approved manufacturer and supplied only through a builder approved by the J/30 Class Association in conformity with the official mast drawing.

Approved mast builders include Hall Spars of Bristol, RI and Rig-Rite, Inc. of Warwick, RI, a supplier of Kenyon Spars.

5.7.2 Measurement Bands of contrasting color, one inch in width, shall be affixed on the mast as indicated in the official mast drawing. The upper edge of the lower measurement band on the mast shall not be more than 2698 mm above the surface of the molded mast step.

5.7.3 Position of the mast shall be fixed at the deck 3505 mm plus or minus 13 mm from stemhead tip to the front edge of the mast. And it shall be permanently fixed to an immovable mast step so that the forward edge of the mast is not less than 25 mm aft of the forward vertical face of the molded step in the sole liner.

5.7.4 Mast hardware and spreaders may not be deleted, modified, or replaced by other than an authorized builder, except as herein provided. The angle of the spreader shall not be changed nor shall the length of the spreader be changed.

5.7.4.1 The spreader brackets and mast may be repaired or reinforced to prevent the spreader brackets from pulling away from the mast.

5.7.4.2 A system may be retrofitted to existing masts and fitted to new masts consisting of a metal strap welded, bolted or riveted to the spreader brackets and going around the front of the mast to connect the brackets.

5.7.4.3 Internal support structures such as bars or plates may be used and spreader brackets may be bolted through the mast.

5.7.4.4 *Use of the Rig-Rite Stainless Steel Jib Box Assembly: K-10658 (supplied as original equipment on earlier masts) or Aluminum Jib Box Assembly: K-11597-1 (supplied as original equipment on later masts) is authorized. The intersection point of the forestay fair extension and the mast front face shall be the same height and forward extension from the mast face so that the position of the headstay measurement point is identical in accordance with rule 5.2.8.1 and the J/30 Mast Specification standard drawing provided in the class rules "J/30 Basic Specifications" section.*

5.8 Standing Rigging may not be altered in material, design or added to except as herein provided.

5.8.1 Permitted Alternatives:

5.8.1.1 Jib roller furling system to facilitate sail handling.

5.8.1.2 Jib luff groove systems other than that which is provided standard shall not have a fore-and-aft dimension exceeding 31 mm.

5.8.1.2.1 *Use of a bare metal head stay and hanks on jibs.*

5.8.1.3. Prohibited while racing from the preparatory signal until the finish:

5.8.1.3.1 Adjustment of the mast step.

5.8.1.3.2 Adjustment of the turnbuckles on the shrouds, backstay and forestay.

5.8.2 Prohibited Alternatives or Additions:

5.8.2.1 A headstay length which exceeds 10935 mm when measured from pin to centerline as shown in the following diagram. (See figure 1.)

Figure 1

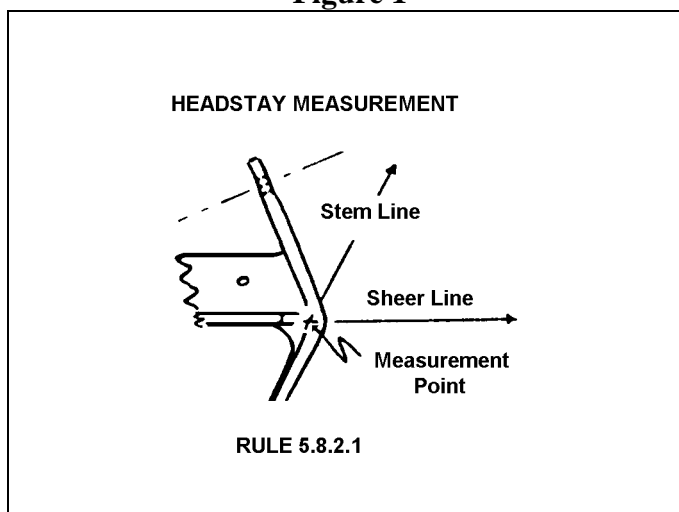

5.8.2.2 Use of quick throw devices, tracks, or levers on shrouds or a headstay which is adjustable while sailing.

5.8.2.3 Running backstays or arrangements to duplicate such.

5.8.2.4 Use of hydraulics anywhere for any purpose.

5.9 Running Rigging may not be altered in material, design, or added to except as herein provided.

5.9.1 Permitted Alternatives:

5.9.1.1 Replacement of wire rope and/or rope of equivalent strength to that supplied by the builder.

5.9.1.2 Substitute blocks or cleats for headsail sheets, mainsail sheets, backstay adjuster, traveler controls, cunningham, outhaul, reefing gear, foreguy and vang. Relocation of deck blocks, fairleads, and cleats, for spinnaker sheets, topping lift, foreguy, backstay adjuster, traveler controls, cunningham, outhaul, reefing gear, twings, and halyards.

Double-ending of the backstay adjuster, mainsheet fine-tuning controls (if installed) and foreguy. Power ratios on all block and tackle systems are unrestricted.

5.9.1.3 Snap shackles or clips at the end of headsail sheets.

5.9.1.4 Barber hauling and twing devices as covered in 5.4.1.1. Devices used to barberhaul headsails shall be attached a minimum of 250 mm outboard of the existing tracks.

5.9.1.5 Light air spinnaker sheets and guys of any material and size.

5.9.1.6 Aramid sheets or ropes.

5.9.1.7 Solid mechanical boom vang.

5.9.1.8 Addition of two single blocks, two cleats and line attached to the spinnaker pole ring car on the mast for the sole purpose of controlling the vertical position of the inboard end of the spinnaker pole.

5.9.1.9 Removal of the boom topping lift.

5.9.2 Prohibited Alternatives or Additions:

5.9.2.1 Spinnaker guy strut.

5.9.2.2 Mainsheet pennants.

5.10 Main Boom

5.10.1 Material shall be aluminum alloy extrusion with a continuous fixed groove integral with the section, and shall be produced only by an approved manufacturer and supplied only through a builder approved by the J/30 Class Association. Approved boom section must conform to Kenyon “E” Section dimensions as follows:

Depth = 114 mm, Width = 69 mm, Wall Thickness = 2.6 mm.

5.10.2 Measurement Band of contrasting color shall be affixed on the boom with its inner edge not more than 3962 mm from the aft side of the mast.

5.11 Spinnaker Pole

5.11.1 Material shall be of either aluminum alloy extrusion or carbon fiber. The diameter of the an aluminum spinnaker pole shall not be less than 2 7/8 inches and a carbon fiber spinnaker pole shall have a uniform diameter through out of not be less than 2 ½ inches.

5.11.2 Length from tip to tip of the pole shall not exceed 3810 mm nor when attached to the fitting at the mast, extend more than 3842 mm from the face of the mast.

5.11.3 Spinnaker end fittings can be of aluminum or composite material such as the Forespar “ultra” series. A trigger mechanisms for holding the jaws open is not permitted.

5.12 Sails

5.12.1 General

5.12.1.1 Sails shall be constructed and measured in accordance with the ISAF sail measurement instructions except where otherwise stated herein.

5.12.1.2 Mainsail shall be manufactured from woven ply polyethylene terephthalate ("PET"), such as Dacron®, or woven ply polyethylene naphthalate ("PEN"), such as Pentex®. The spinnaker shall be manufactured from woven ply nylon.

5.12.1.3 Sailcloth in the #1, #2 and #3 Genoa is not restricted.

This change in approved sailcloth goes into effect no later than October 17, 2005. Individual J30 Class Districts may adopt this change for local events at an earlier date.

5.12.1.4 Sail numbers shall be placed immediately above the third batten (#2 sewn from the head of the mainsail) on the #1 and larger genoa in line with the mainsail numbers and on the spinnaker. The starboard or forward number shall be on top.

5.12.1.5 Genoa #2 is optional and does not need to be on board while racing.

5.12.1.6 Numbers shall be of the following dimensions in solid black, red, green or blue: height = 380mm, width = 254mm, thickness = 57-77mm, spacing = 77mm.

5.12.1.7 Windows. There is no limit on the number or design of collision, telltale, or spreader tip windows on the mainsail or genoas.

5.12.2 Mainsail

5.12.2.1 Minimum cloth weight is 6.25 oz.

5.12.2.2 The length of the leech, measured in a straight line from the head to the clew, shall not exceed 12.395 m.

5.12.2.3 The width of the sail from the midpoint of the leech to the nearest point on the luff, including the bolt rope, shall not exceed 2621 mm.

5.12.2.4 The width of the headboard measured at right angles to the mast shall not exceed 158 mm.

5.12.2.5 There shall be four batten pockets. Spacing between battens and the nearest part of the headboard and clew shall not be less than 2300 mm as measured along the leech. The angle of the battens to the mast may vary on each batten. The battens may not cross the line between the luff and leech of each reef. The length, material and construction of battens are unrestricted.

5.12.2.6 One reef shall be included at least 1675 mm above the tack at the luff and perpendicular to the mast. At least two intermediate grommets must be built into the sail on each reef. Additional reefs above the mandatory reef are permitted.

5.12.2.7 A clam opening shelf and/or flattening reef (with the outhaul grommet no higher than 305 mm from the clew grommet, measured on grommet centerlines) is permitted. An optional foot rope may be fitted in the boom groove while racing.

5.12.3 Genoa (#3)

5.12.3.1 The length of the LP shall not exceed 3658 mm nor be less than 3550 mm.

5.12.3.2 One reef point may be included with a maximum height of 1220 mm along the luff from the center of the tack. Cunninghams are not permitted.

5.12.3.3 Maximum luff length is 9982 mm (32.75').

5.12.3.4 Up to three battens are permitted between the head and the clew evenly spaced on the leech. The length, material and construction of battens are unrestricted.

5.12.4 Genoa (#2)

5.12.4.1 The length of LP shall not exceed 4907 mm nor be less than 4800 mm.

5.12.4.2 No reef points or cunninghams are allowed.

5.12.4.3 Maximum luff length is 10.515 m (34.5').

5.12.5 Genoa (#1)

5.12.5.1 The length of LP shall not exceed 5665 mm nor be less than 5250 mm.

5.12.5.2 The length of the leech shall permit windward trimming to the existing genoa tracks.

5.12.5.3 No reef points or cunninghams are allowed.

5.12.5.4 Maximum luff length is 10.670 m.

5.12.6 Spinnaker

5.12.6.1 Minimum cloth weight is 40 grams or 0.75 oz. nominal and 0.9 oz. actual weight. Spinnakers must be made of nylon. Airex 650 is one of several approved spinnaker cloths that meet this requirement.

5.12.6.2 The maximum length of the leeches is 10.515 m. The half width at half height, measured from midpoint of the leeches to the nearest point on the centerfold shall not exceed 3429 mm (11.25'). The foot shall be contained by a 110° angle from the clews. Maximum spinnaker half width at any point on the luff shall not exceed 3429 mm.

5.13 Auxiliary Engine and Propeller

5.13.1 Weight. The engine dry weight including adjacent batteries shall not be less than 145 kg.

5.13.2 Manufacturer. The engine used must be from a supplier and of a type approved by J/Boats, Inc.

5.13.3 Propeller, shaft and strut shall be in accordance with the standard installation with a propeller diameter of not less than 356 mm.

5.13.4 Removal of the engine cooling water intake screen is permitted.

5.14 Sailing Weight

5.14.1 Comparable sailing weight among boats shall be achieved through the use of draft marks located on the stem and on the rudder of each boat. Draft marks shall be 12 mm wide and extend aft at least 100 mm from the leading edge on both sides of the stem and rudder. Draft marks are to be painted on by owners or molded by the builder in sharply contrasting color. Local fleets or event organizers for a J/30 One-Design event or series may waive this requirement for draft marks. In the case of a waiver, the sailing weight may be determined by measuring the distance as specified herein for the location of the draft marks.

5.14.2 The Bottom of the stem mark shall be 1403 mm down the stem from an extension of the line formed by the top of the hull flange at the stem, not including the deck. (See figure 2.)

Figure 2

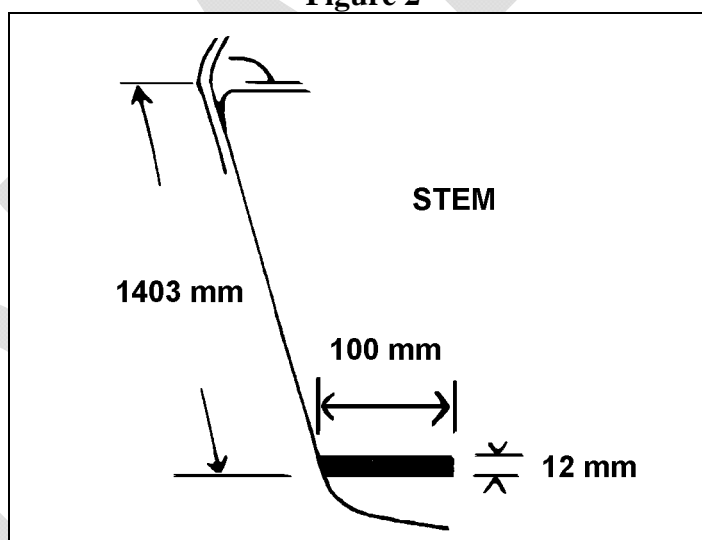

5.14.3 The bottom of the rudder mark shall be 853 mm down from an extension of the line formed by the top of the hull flange at the center of the transom. (See figure 3.)

Figure 3

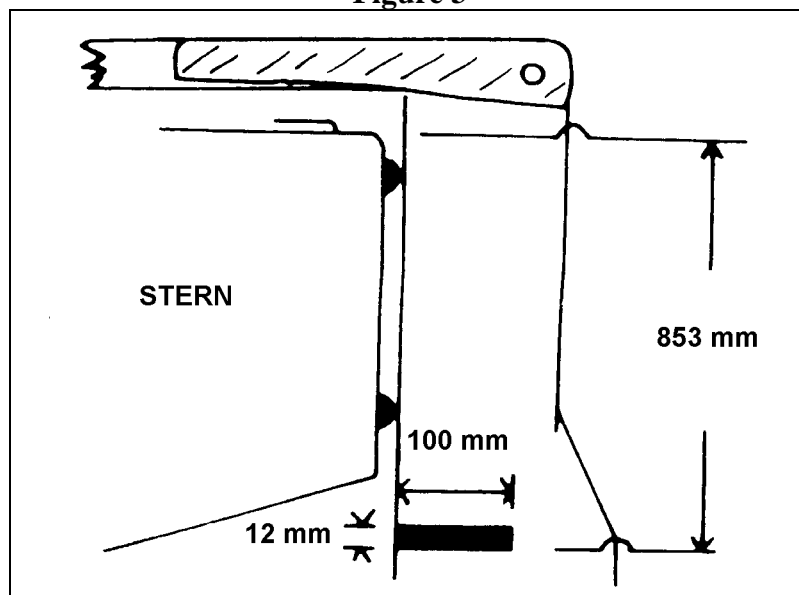

5.14.4 When in sailing trim (without crew) with all supplies, sails, stores, tankage, and sailing gear, the bottom of both lines should touch the water.

5.15 Official Class Identification

5.15.1 Color is solid PMS Reflex blue, black, red or green. Outline insignias are prohibited.

5.15.2 Location on the mainsail shall be formed by two 400 mm x 800 mm rectangles located on top of one another and between the top and next lower battens, centered on a line drawn from the center of the headboard to the center of the mainsail foot. The top of the “J” on the port side shall be approximately 100 mm from the bottom of the “3” on the starboard side.

5.15.3 Design of the insignia shall be as indicated in the *sail plan shown in the class specifications*.

6. Additional Rules

6.1 Instruments. The following instruments are permitted for one-design racing.

6.1.1 One electronic device transmitting wind direction and speed.

6.1.2 One electronic device transmitting boat speed and distance.

6.1.3 One electronic device transmitting water depth.

6.1.4 Mechanical telltales of any kind.

6.1.5 Navigational devices of any type.

6.1.6 VHF, CB or similar transmitter radios.

6.1.7 Compasses and mechanical trim indicators.

6.2 Sails

6.2.1 The number of sails on board during a regatta series or race shall be four: #1, and #3 genoas , mainsail and spinnaker. A second spinnaker may be carried on board, but only used if the primary spinnaker is damaged. The #2 is optional.

6.2.2 A local fleet may adopt, for local racing only, a rule to carry additional sail or sails such as a storm jib for heavy wind areas, or when sailing in long distance or offshore events.

6.2.3 Alteration or substitution of sails during a regatta series is not permitted. A sail damaged beyond repair may be replaced with the approval of the host fleet measurer or event organizer, as appropriate.

6.2.4 Except as provided herein, each class sail may be replaced a maximum of once in a calendar year. If a new sail is damaged beyond repair, it may be replaced only with the approval of the local fleet governing body. Local fleets may further limit replacement of sails and restrict the use of old sails after they are replaced.

6.3.1 Pumping of the spinnaker guy or halyard under any conditions is prohibited. Pumping of the spinnaker sheet or main sail is restricted to one pump per major wave.

6.3.2 Hanging on the mast or shrouds to promote roll tacking or gybing is prohibited at all times. Under the racing rules, roll tacking or roll gybing shall not be a "necessary task."

6.4 Safety Gear and Equipment. In addition to safety equipment required by Coast Guard and local regulations, the following equipment shall be carried onboard for one design racing.

Coast Guard Required

- Fog horn
- Two fire extinguishers of type and capacity required by local and Coast Guard regulations
- PFD for each member of the crew
- One throw-able lifesaving device within reach of the helmsman
- Distress signals meeting Coast Guard requirements
- Permanently installed navigation lights in working order

One Design Required

- Fixed non-electric compass
- One anchor and rode
- One permanently fitted manual bilge pump operable from the cockpit with all hatches, lockers and companionways closed. If handle is removable, it shall be tethered to prevent loss
- Depth sounder (or lead line)
- Radio receiver capable of receiving weather bulletins
- First Aid Kit and manual

- Five soft wood plugs of size to fit each below waterline through hull fitting
- Two rigid buckets with lanyards having a minimum capacity of two gallons each
- Heaving line (minimum 50' length) within reach of the helmsman

Optional Suggested Equipment (Optional safety equipment listed is suggested, but not required)

- Equipment capable of disconnecting or severing the standing rigging
- Two water resistant flashlights
- Radar reflector (with minimum diameter of 8-10")

For local and national events the notice of race and sailing instructions may require additional safety equipment.

6.5 Storage of Gear. Use of other than normally required sailing gear in normal, designed or proper storage areas to attain sailing displacement is prohibited. The intent of this rule is to prevent use of lead pigs, excess tools, winch handles in bags, unattached anchor chain, or other high density materials to reach sailing weight with optimized moments of inertia.

The anchor shall be stored in the anchor well. A minimum of six feet of chain shall be attached to the anchor or the anchor line.

6.6 Helmsman Rule

6.6.1 Any helmsman racing in a one-design Class event shall be an owner of the yacht he is helming. The owner or owners shall helm the yacht from the warning signal until the finish except for momentary absence due to personal, safety, or shipboard needs.

6.6.2 In one-design Class distance races designated by the local fleet, the owner or owners shall helm from the warning signal and for the first hour, for at least one-third of each leg, during all mark roundings, and for approximately the last hour of the race until finished.

6.6.3 An owner is any person who legally owns 100% of the yacht or is at least a twenty-five percent partner in terms of financial investment in the purchase of the complete yacht and the cost of its operations. Ownership shall include long-term charter arrangements of three months or more at fair market value.

6.6.4 (Blank)

6.6.5 Ownership is automatically conferred on the members of the owner's immediate family including children, parents, and spouse.

6.6.6 To be eligible for national championship events, the owner must have been a J/30 Class Association member for at least sixty days prior to the event, helmed the yacht in at least two regattas in the preceding sixty days and satisfied any and all District qualifying requirements. The Class President shall determine eligibility for national events and may alter or waive qualifying requirements in special circumstances.

6.6.7 Owners are eligible to helm another J/30 as if it were their own yacht, if it is loaned or chartered in either an event outside that owner's home waters, or in any case where the owner's own yacht has been damaged and is not capable of being sailed.

6.6.8 Local fleets may waive or modify the Helmsman rule for local events only.

The Class President shall determine eligibility for national events and may alter or waive qualifying requirements in special circumstances.

The Helmsman Rule prescribes that the J/30 is an owner-steered class and that, except as provided herein, the owner shall steer the boat while racing. The owner may, in accordance with the limitations above, utilize a regular crewmember as a relief helmsman. While owners are encouraged to utilize sailing professionals as crew, their primary role should be instructional.

6.7 Crew Weight Limit

The maximum crew weight (in swimming apparel) for one design racing is 635 kg (or 1400 pounds) with no limit on number of crew. If the sailing instructions require a weigh-in prior to the start of a regatta a boat complying with the weight restrictions at weigh-in shall not otherwise be subject to a weigh-in during or after the regatta, except for weighing substitute crew. The crew limit may be waived or modified by local fleets or event organizers for any event other than the North American Championships or the Mid-Winter Championships.

6.8 Other Provisions. Local fleets are authorized to adopt additional rules providing they are more restrictive than these Class Rules and do not contradict them.

6.9 Conduct of North American Championship Regatta

6.9.1 Measurement at the North American Championship regatta shall be directed by the J30 Class and J30 National Class Measurer or his designee.

Basic Specifications

LOA	29.92'	Displacement (Approx.)	
LWL	25.00'	Factory	6,000 lb.
Beam	11.20'	Sailing	6,700 lb.
Draft	5.25'	Ballast (Lead Keel)	2,100 lb.
I	34.00'	Mast Height over Water	46'
P	38.00'	Auxiliary 15 h.p. Inboard Diesel	
E	13.0'		
J	11.5'		
Sail Area (sqft)			
Main	247		
Jib	196		
Genoa	294		
Spinnaker	704		

Frequently Used Measurements

1 mm = 0.03937 inch

1 m = 39.37 inch

1 inch = 25.4 mm

LOA	29' 11"	Specs
Beam	11' 2 1/2"	Specs
Stem to front of mast (J)	3505±13mm	11' 6" ±1/2" 5.7.3
Mast step	≥ 25 mm	≥ 1" 5.7.3
Spinnaker pole tip-to tip	≤ 3810 mm	≤ 12' 6" 5.11.2
Measurement bands		
Mast, lower, upper edge	≤ 2698 mm	≤ 8' 10 1/4" 5.7.2
Mast, upper, lower edge	≤ 14280 mm	≤ 46' 10 3/16" specs
Mast, distance between (P)	≤ 11582 mm	≤ 38' specs
Boom, inner edge (E)	< 3962 mm	< 13' 5.10.2
Headstay length	≤ 10935 mm	≤ 35' 10 1/2" 5.8.2
Keel and Rudder, trailing edge	≥ 5 mm	≥ 3/16" 5.5.4, 5.6.1
Draft Marks		
Stem, lower edge	= 1403mm	≥ 4' 7 1/4" 5.14
Rudder, lower edge	= 853 mm	≥ 2' 9 9/16" 5.14

Official Keel Drawing & Offsets

(Dimensions in Millimeters)

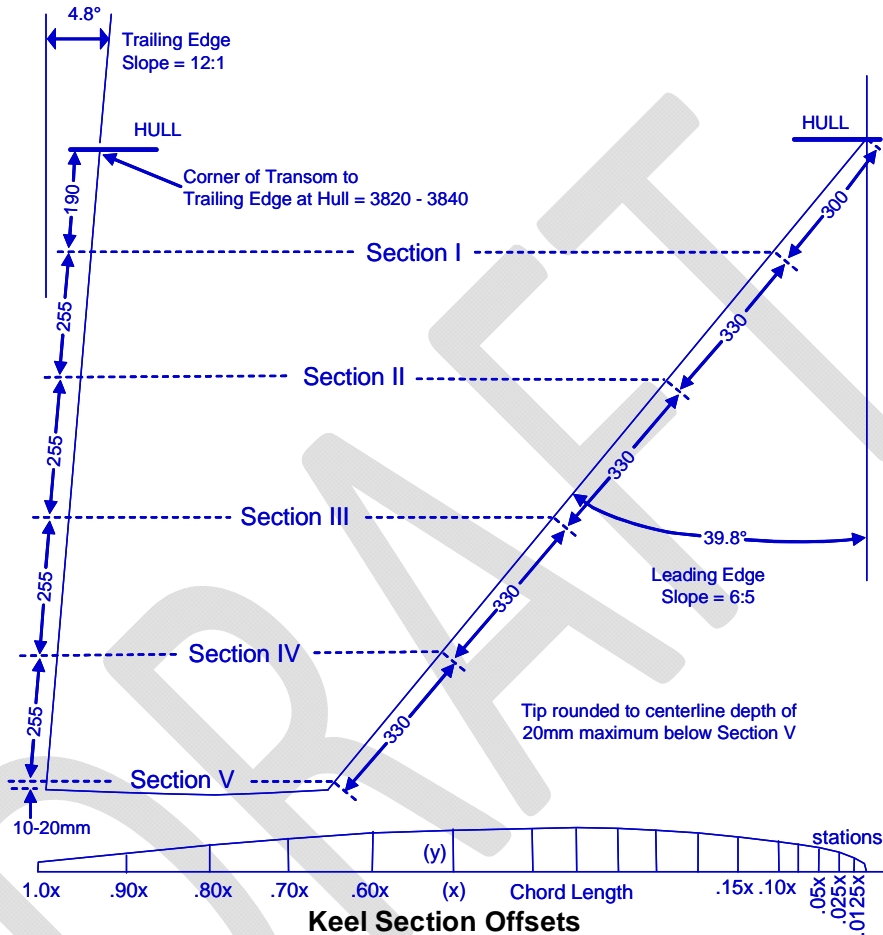

Keel Section Offsets

Location	I	II	III	IV	V
Chord Length	1310	1120	930	740	550
Front - down leading edge from hull	300	630	960	1290	1620
Back - down trailing edge from hull	190	445	700	955	1210
Leading Edge Radius	28.9	24.7	20.5	16.3	12.1
0.0125x	26.2	22.4	18.6	14.8	11.0
0.025x	36.0	30.8	25.6	20.4	15.2
0.05x	49.6	42.4	35.2	28.0	20.8
0.075x	60.7	51.9	43.1	34.3	25.5
0.10x	68.2	58.3	48.4	38.5	28.6
0.15x	78.1	66.8	55.5	44.2	32.9
0.20x	84.5	72.2	59.9	47.6	35.3
0.25x	87.3	74.6	61.9	49.2	36.5
0.30x	88.5	75.7	62.9	50.1	37.3
0.35x	88.5	75.7	62.9	50.1	37.3
0.40x	86.8	74.2	61.6	49.0	36.4
0.50x	77.3	66.1	54.9	43.7	32.5
0.60x	64.9	55.5	46.1	36.7	27.3
0.70x	50.7	43.4	36.1	28.8	21.5
0.80x	34.8	30.1	25.4	20.7	16.0
0.90x	18.8	16.5	14.2	11.9	9.6
1.00x	2.8	2.8	2.8	2.8	2.8

J/30 Keel Template Construction

Keel templates for the J/30 shall consist of five templates and shall be constructed as follows:

1. Lay out each section directly on 1/4" plywood or plastic sheeting. First draw the centerline axis and plot the half-width (y) stations along the chord length (x) as indicated by the official keel table of offsets (Fig. 1). Be sure to notch centerline forward of leading edge and aft of trailing edge for permanent reference.

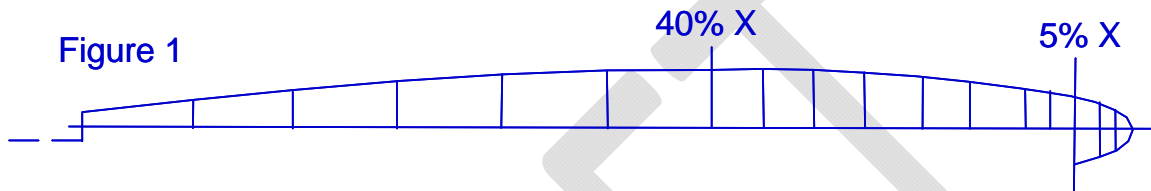

2. Cut template out of material as shown in Figure 2 being sure to leave the pencil outline of the section showing on the rough template. Fair the cut back to the pencil line to achieve perfect fair using sandpaper and a flexible block.

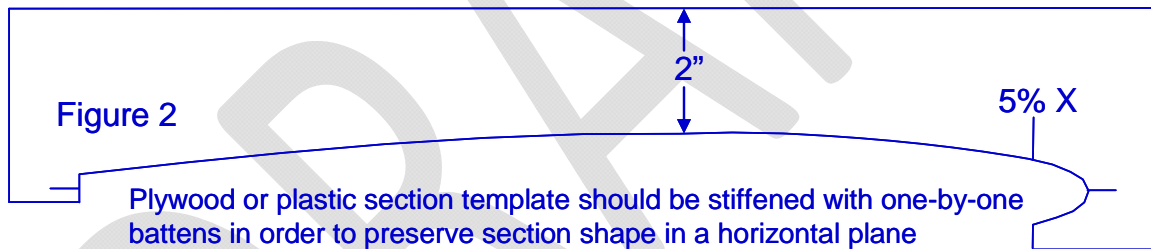

3. Mark off points on the leading edge and trailing edge as specified in the table of offsets. Fit templates to the appropriate marks.

Keel Section Offsets					
Location	I	II	III	IV	V
Chord Length	1310	1120	930	740	550
Front - down leading edge from hull	300	630	960	1290	1620
Back - down trailing edge from hull	190	445	700	955	1210
Leading Edge Radius	28.9	24.7	20.5	16.3	12.1
0.0125x	26.2	22.4	18.6	14.8	11.0
0.025x	36.0	30.8	25.6	20.4	15.2
0.05x	49.6	42.4	35.2	28.0	20.8
0.075x	60.7	51.9	43.1	34.3	25.5
0.10x	68.2	58.3	48.4	38.5	28.6
0.15x	78.1	66.8	55.5	44.2	32.9
0.20x	84.5	72.2	59.9	47.6	35.3
0.25x	87.3	74.6	61.9	49.2	36.5
0.30x	88.5	75.7	62.9	50.1	37.3
0.35x	88.5	75.7	62.9	50.1	37.3
0.40x	86.8	74.2	61.6	49.0	36.4
0.50x	77.3	66.1	54.9	43.7	32.5
0.60x	64.9	55.5	46.1	36.7	27.3
0.70x	50.7	43.4	36.1	28.8	21.5
0.80x	34.8	30.1	25.4	20.7	16.0
0.90x	18.8	16.5	14.2	11.9	9.6
1.00x	2.8	2.8	2.8	2.8	2.8

J/30 Rudder Plan & Offsets

(Dimensions in Millimeters)

Upper limit of Rudder portion faired to Section A

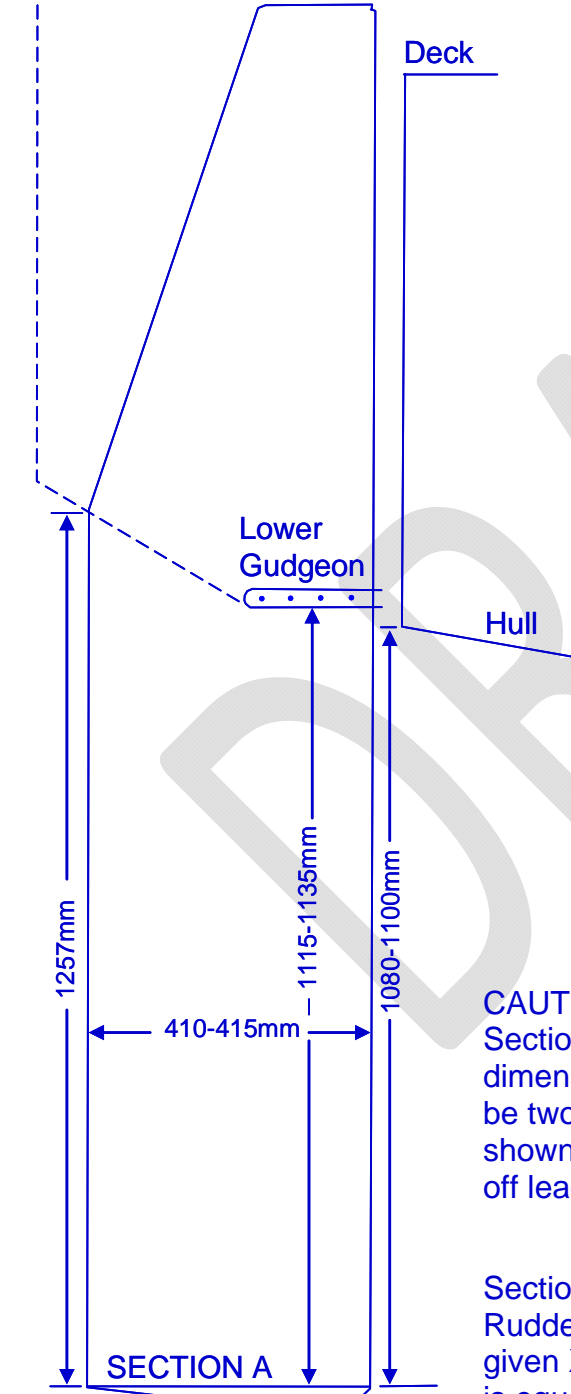

Rudder Offsets

Xc Stations	Yc Half width
5mm	10.0
10mm	12.8
21mm	16.5
41mm	20.6
62mm	23.9
82mm	25.9
103mm	27.2
124mm	28.0
144mm	28.4
165mm	28.3
206mm	26.3
247mm	22.5
288mm	18.0
329mm	12.8
370mm	7.6
Trailing Edge (411mm)	2.4

CAUTION:
Section A Offsets represent minimum dimensions. Half-width thickness may be two millimeters greater than what is shown. Do not sand molded fiberglass off leading or trailing edges.

Section A is perpendicular to the leading and trailing edges. Rudder tip is rounded and is defined by a semi-circle at any given Xc Station below the lower limit of Section A whose radius is equal to Yc thickness at that station

SECTION A

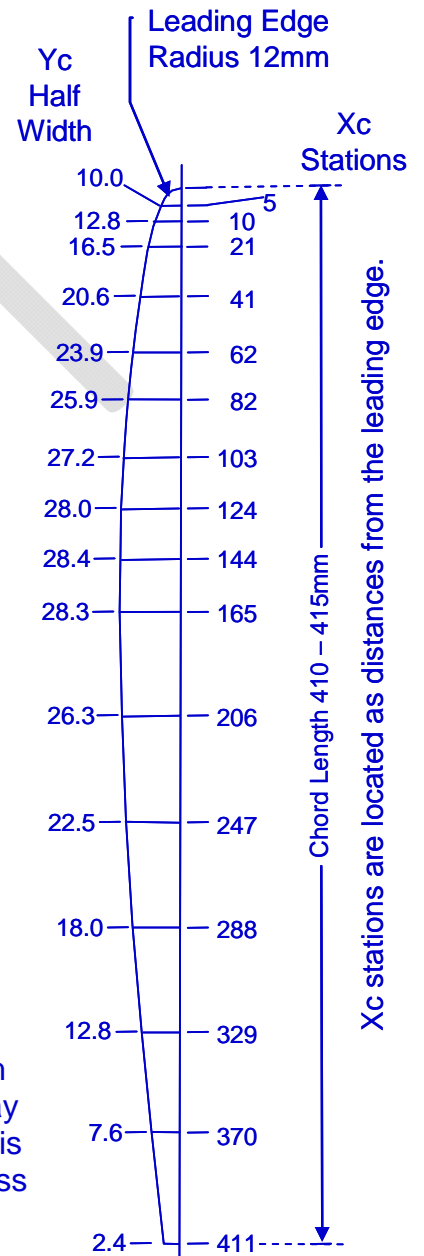

J/30 Shaft, Strut, and Propeller Installation Standard

Standard specifications as they relate to Class Rule 5.13.3 and to I.O.R. measurement terms.

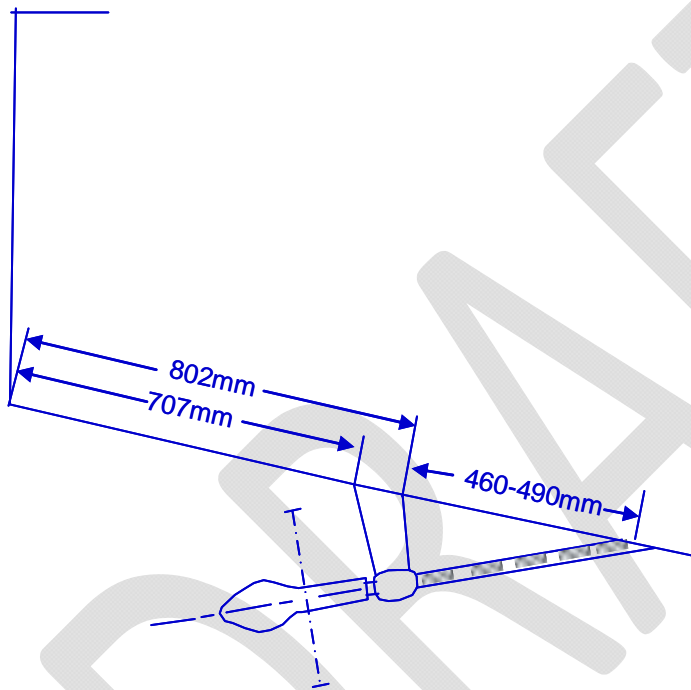

Propeller: Standard propeller is folding two-bladed Martec Design Number 23780 – Right Hand, 14 inch diameter, 14 pitch elliptical for 3/4 inch shaft.

Strut: Cast bronze installed in molded recess in hull. Pertinent I.O.R. dimensions as follows: ST 1 = 18mm, ST 2 = 70mm, ST 3 = 79mm

Other: I.O.R. dimensions:
ESC = 201mm
ESL = 670mm
PRD = 356mm

Reference: J/30 Class Rules and I.O.R Mark III

J/30 Mast Specifications Standard

Standard specifications as they relate to Class Rule 5.7 and to I.O.R. measurement terms.

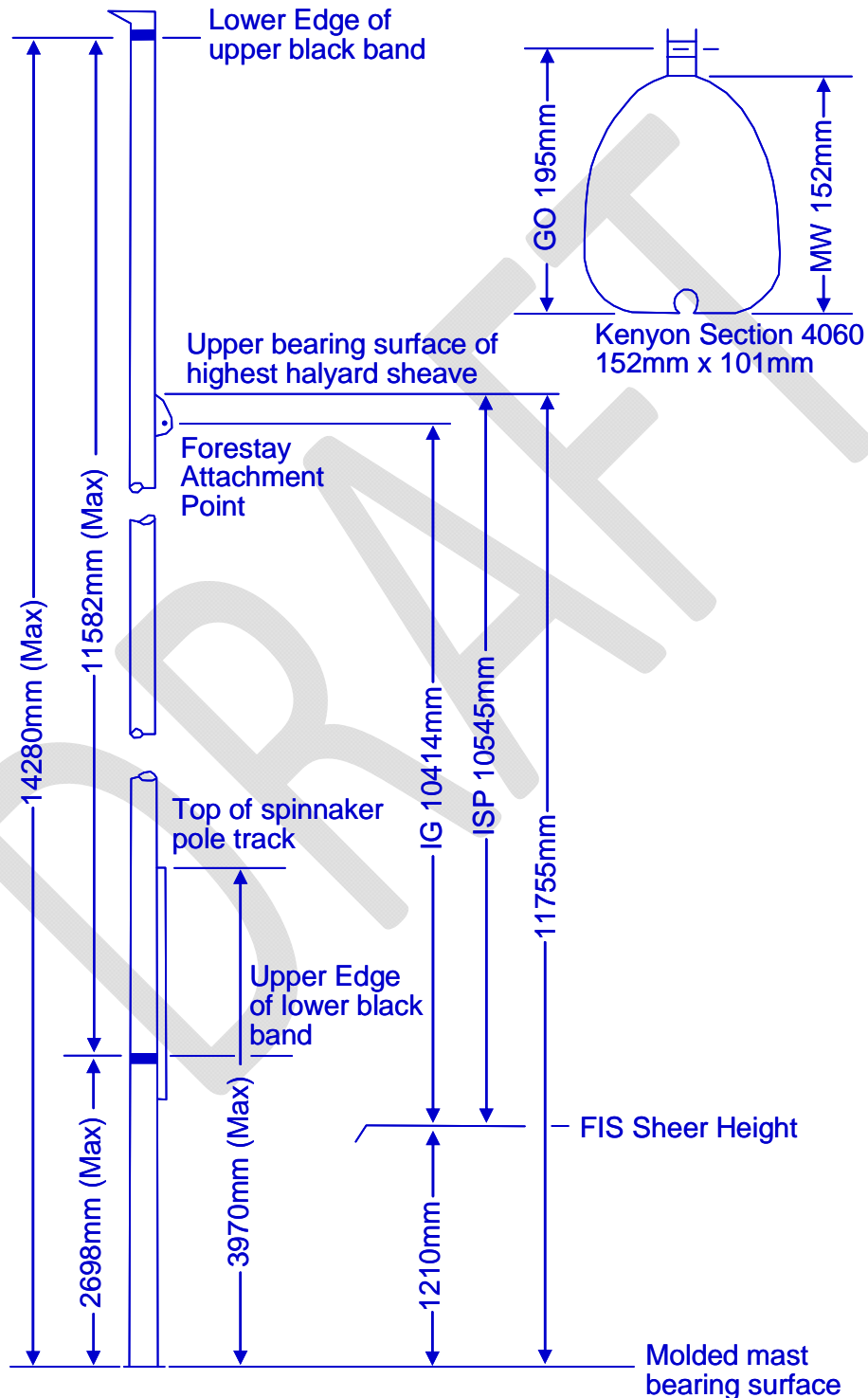

Reference: J/30 Class Rules and I.O.R Mark III

Sail Plan



Scale = 50 mm

J/30 insignia per
rule 5.15.3

